

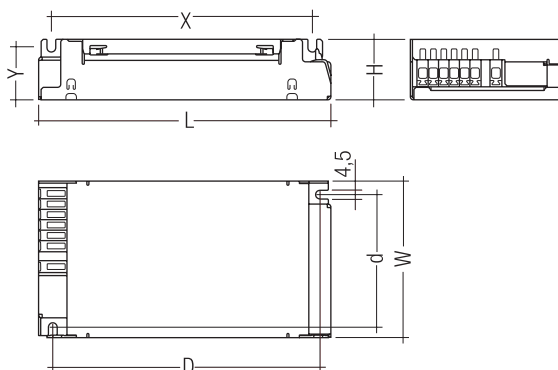

powerCONTROL PCI PRO C011 Single Build-in applications

Product description

- For metal halide lamps
- Also for mobile luminaires with connectors
- Pulse packets for increased ignition energy (pulseCONTROL technology)
- With patented circuit elements
- Flicker-free light
- Colour stability thanks to constant power
- Guaranteed long life
- No acoustic resonance
- Safety shutdown if a lamp is faulty or missing
- Greatly reduced reignition time
- Hardly any EMC interference in the ignition phase
- Automatic shutdown on overheating
- Multiwatt: two lamp wattages with one device
- Casing: aluminium (PCI 20/22 PRO steel)
- Plug-in terminals up to 2.5 mm²
- Excellent thermal behaviour



Technical data

AC voltage range	198 – 254 V
DC voltage range	198 – 320 V (at 22, 50, 70, 150 W)
Mains frequency	50 / 60 Hz
Operating frequency	145 Hz
Max. ignition voltage	5 kVp (2 kVp at 22 W)
Type of protection	IP20



Standards, page 2

Wiring diagrams and installation examples, page 2, 3

Ordering data

Output, lamp	Lamp type	Type	Article number
For luminaires with 1 lamp			
20 / 22 W	HI	PCI 20/22 PRO C011	86458600
35 / 50 W	HI	PCI 35/50 PRO C011	86459307
35 / 70 W	HI	PCI 35/70 PRO C011	86458601
100 / 150 W	HI	PCI 100/150 PRO C011	86458602

Packaging PCI 20/22: 15 pieces/carton, 1350 pieces/pallet

Packaging PCI 35/50: 15 pieces/carton, 900 pieces/pallet

Packaging PCI 35/70: 15 pieces/carton, 900 pieces/pallet

Packaging PCI 100/150: 15 pieces/carton, 900 pieces/pallet

Specific technical data

Type	Dimensions LxWxH	Hole spacing D	Hole spacing d	Hole spacing (X)	Hole spacing (Y)	Weight	Mains current	Lamp wattage	Circuit power	λ	Max. cable length to lamp	tc point max.	Ambient temperature ta
For luminaires with 1 lamp													
PCI 20/22 PRO C011	90x59x29 mm	78–80 mm	47.0–49.0 mm	75.5 mm	25 mm	0.150 kg	0.1/0.10 A	20/22 W	23.0/25.5 W	0.95	2 m/160 pF	75 °C	-25 ... +55 °C
PCI 35/50 PRO C011	100x75x29 mm	88–90 mm	63.5–65.5 mm	85.0 mm	25 mm	0.204 kg	0.2/0.25 A	39/50 W	43.5/55.0 W	0.96	5 m/400 pF	80 °C	-25 ... +65 °C
PCI 35/70 PRO C011	100x75x29 mm	88–90 mm	63.5–65.5 mm	85.0 mm	25 mm	0.204 kg	0.2/0.35 A	39/73 W	43.5/79.0 W	0.97	5 m/400 pF	80 °C	-25 ... +50 °C
PCI 100/150 PRO C011	140x75x29 mm	128–130 mm	63.5–65.5 mm	125.0 mm	25 mm	0.305 kg	0.5/0.70 A	100/147 W	108.0/158.5 W	0.97	5 m/400 pF	80 °C	-25 ... +50 °C

Installation instructions

Wiring type and cross section

Stranded wire or solid wire up to 2.5 mm² may be used for wiring. Strip 10–11 mm of insulation from the cables to ensure perfect operation of the push-in terminals.

Use one wire for each terminal connector only.

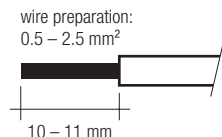

Note on wiring

The length of the lamp wires is limited by the value of cable capacitance. The maximum of 400 pF* would enable connection of approximately 5 m* of lamp wire.

* 2 m / 160 pF for PCI 20/22 PRO

To avoid the damage of the control gear, the wiring must be protected against short circuits to earth (sharp edged metal parts, metal cable clips, louver, etc.).

In class 1 luminaires it is necessary to earth the ballast and the luminaire via the earth terminal, in class 2 luminaires not.

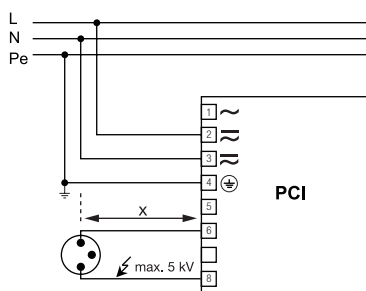

Circuit diagram PCI class 1 application

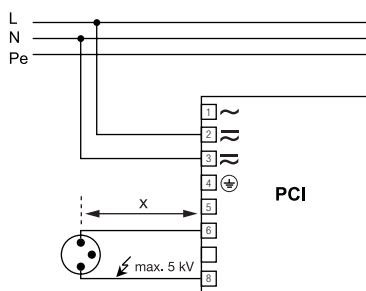

Circuit diagram PCI class 2 application

Mounting recommendation

The PCI-C has an excellent thermo management. Optimum heat transport can help improving the lifetime. Whenever possible keep the ballast away from hot parts.

To ensure optimum heat removal the ECG should be mounted on a metal plate (luminaire body). No insulators between the ECG and the cooling surface (air, adhesive tape, etc.). Finally important remains the temperature measurement.

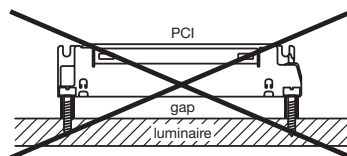
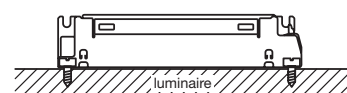

If several ballasts are installed in masts, boxes, etc., measures must be taken to avoid overheating of individual components.

Radio interference

- Do not cross mains and lamp cables.
- Do not lay mains cables together with lamp cables (ideally they should be 5–10 cm apart).
- Do not lead mains cables too closely along the electronic ballast.
- Twist lamp cables.
- Increase the distance between lamp cables and earthed metal surfaces.
- Keep the mains cable in the luminaire short.
- Parallel runs (x) of mains and lamp cables must be kept as short as possible.
- Connection to earth reduces radio interference.

Important advise

When a lamp is changed (at the end of its life), if a lamp is missing or after overtemperature shutdown the mains voltage of the ECG must be disconnected.

Warning – starting voltage up to max. 5 kV!

Not suitable for use with lamps with integral ignitors. A list of released lamps for the safe operation with PCI can be found on www.tridonic.com → Techn. Data → Lamp matrix → Lamp Matrix for HID

Safety switch off

End of life of the lamps

At the end of their useful life, lamps often cycle on/off. The PCI ballast recognises this condition and switches off the lamp, after three complete on/off cycles and whilst the supply has been unswitched. Complete lamp switch off enables easy identification of a defective lamp in the application. After a change of the faulty lamp and an interruption of the mains supply (mains reset) the ballast will strike the lamp. When there is no lamp in circuit or a defective lamp is connected to the ballast, the ballast will switch off after apr. 25 minutes.

Overtemperature shutdown

The units shut down at Δt approx. +12 ... +19 °C compared with tc. A mains reset must be carried out so that the units switch on again.

Overload strength

320 V_{AC} / 1 h
280 V_{AC} / 10 h

Standards

- EN 55015 (radio interference)
- EN 61000-3-2 (mains harmonics)
- EN 61347-2-12
- EN 61547 (interference immunity)
- EN 61167

Harmonic distortion in the mains supply

Type	THD at 230 V/50 Hz
PCI 20/22 PRO	< 12 %
PCI 35/50 PRO	< 10 %
PCI 35/70 PRO	< 10 %
PCI 100/150 PRO	< 12 %

Ballast lumen factor EN 60929 8.1

Type	AC/DC-BLF at U = 198–254 V, 25 °C
PCI 20/22 PRO	1.00
PCI 35/50 PRO	1.00
PCI 35/70 PRO	1.00
PCI 100/150 PRO	1.00

Loading of automatic circuit breakers

Automatic circuit breaker type	C10	C13	C16	C20	B10	B13	B16	B20
Installation Ø	1.5 mm ²	1.5 mm ²	1.5 mm ²	2.5 mm ²	1.5 mm ²	1.5 mm ²	1.5 mm ²	2.5 mm ²
PCI 20/22 PRO	30	40	50	60	15	20	25	30
PCI 35/50 PRO	14	25	36	42	8	14	18	18
PCI 35/70 PRO	14	25	36	42	8	14	18	18
PCI 100/150 PRO	7	14	20	20	4	6	7	7

Multi wattage power selection

The PCI PRO C011 are able to operate two different wattages. As a result of the lamp characteristics an automatic detection is not possible. The wattage selection is done via mains terminals. For using the lower power lamp connect the mains on the terminals [1] and [3]. For using the higher power lamp connect the mains on the terminals [2] and [3]. Do not connect the mains on the terminals [1] and [2] as this would destroy the device!

To avoid the use of a wrong lamp we recommend to mark the luminaire with the correct lamp type.

The unused multi wattage terminal [1] or [2] can lead mains voltage.

Correct mains setup

It is important to run the ballast only with the lamp set at the mains terminals. Over powering of the lamp will lead to a shorter lifetime or destruction of the lamp. Under powering may lead to an early shutdown or colour shifts in the lamp as well as a shorter life time.

Note on PCI 20/22 PRO C011

That ballast is designed to drive a standard 20 W lamp as well as 22 W lamps*. In this setup 20 W lamps cannot be ignited.

* Philips CDM-TM 20

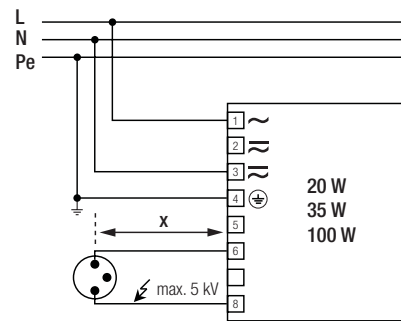

Circuit diagram multiwatt for 20, 35 and 100 W

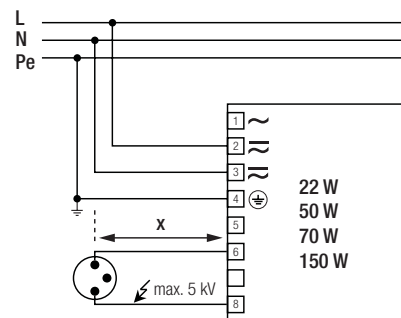

Circuit diagram multiwatt for 22, 50, 70 and 150 W

Temperature range

The t_a temperature value is the basis for specifying the rated life.

The relationship between the t_c temperature and the t_a temperature depends on the design of the luminaire. If the measured t_c temperature is approximately 5 K under the t_c max. temperature the t_a temperature should be checked and, if necessary, measurements should be taken on the critical components (e.g. electrolytic capacitor).

Detailed information is available on request.

PCI PRO C011 is designed for an average life of 50,000 hours under rated conditions, with a failure probability of less than 10 %. This corresponds to an average failure rate of 0.2 % per 1,000 hours of operation.

The specified t_c temperature is the maximum permitted value (rated temperature according to EN 61347 -1). Above this safety-related value the thermal cutout protects the device against damage.

The expected lifetime values are shown in the following table. The t_c values are the relevant values here.

Expected lifetime

Type	Lamp type	Lamp power	ta	45 °C	50 °C	55 °C	60 °C	65 °C	70 °C
PCI 20/22 PRO	HI	1x20 W	tc	60 °C	65 °C	70 °C	75 °C	x	x
			Lifetime	> 75,000 h	75,000 h	55,000 h	40,000 h	x	x
	HI	1x22 W	tc	60 °C	65 °C	70 °C	75 °C	x	x
			Lifetime	> 75,000 h	75,000 h	55,000 h	40,000 h	x	x
PCI 35/50 PRO	HI	1x35 W	tc	55 °C	60 °C	65 °C	70 °C	75 °C	80 °C
			Lifetime	> 55,000 h	> 55,000 h	> 55,000 h	55,000 h	40,000 h	25,000 h
	HI	1x50 W	tc	60 °C	65 °C	70 °C	75 °C	80 °C	x
			Lifetime	> 55,000 h	> 55,000 h	55,000 h	40,000 h	25,000 h	x
PCI 35/70 PRO	HI	1x35 W	tc	55 °C	60 °C	65 °C	70 °C	75 °C	80 °C
			Lifetime	> 55,000 h	> 55,000 h	> 55,000 h	55,000 h	40,000 h	25,000 h
	HI	1x70 W	tc	65 °C	70 °C	75 °C	80 °C	x	x
			Lifetime	> 55,000 h	55,000 h	40,000 h	25,000 h	x	x
PCI 100/150 PRO	HI	1x100 W	tc	65 °C	70 °C	75 °C	80 °C	85 °C	x
			Lifetime	> 70,000 h	> 70,000 h	70,000 h	50,000 h	35,000 h	x
	HI	1x150 W	tc	70 °C	75 °C	80 °C	x	x	x
			Lifetime	70,000 h	50,000 h	35,000 h	x	x	x

x ... not permitted

Storage conditions

Humidity: 5 % up to max. 85 %,
not condensed
(max. 56 days/year at 85 %)

Storage temperature: -40 °C up to max. +80 °C

The devices have to be within the specified temperature range (ta) before they can be operated.

Isolation and electric strength testing of luminaires

Electronic devices can be damaged by high voltage. This has to be considered during the routine testing of the luminaires in production.

According to IEC 60598-1 Annex Q (informative only!) or ENEC 303-Annex A, each luminaire should be submitted to an isolation test with 500 V_{DC} for 1 second. This test voltage should be connected between the interconnected phase and neutral terminals and the earth terminal.

The isolation resistance must be at least 2 MΩ.

As an alternative, IEC 60598-1 Annex Q describes a test of the electrical strength with 1500 V_{AC} (or 1.414 x 1500 V_{DC}). To avoid damage to the electronic devices this test must not be conducted.

Additional information

Additional technical information at
www.tridonic.com → Technical Data

Guarantee conditions at
www.tridonic.com → Services

No warranty if device was opened.